

ΚΡΑΤΟΣ

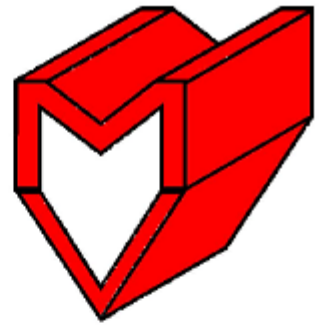

ÓÚΖΟΪΤ ΟΕΪΥΘ ΟΕΪΘΕ
€€€ Η ΙΗ ΓΓΓΪ Ι Ι
^|æã [O à] : æ ã ~ ð æã•

**UTENSILI E ATTREZZATURE
PER PRESSE PIEGATRICI**

**PRESS BRAKE TOOLING
AND EQUIPMENT**

Ôææ [* [Á^Á
O&&^• [! ã •



LVD **Cod.14.106** 100 T/m

CONTENITORI ED INSERTI A Z / JOGGLE Z TOOL HOLDER AND INSERT

AMADA/PROMECAM

Cod.11.500 100 T/m

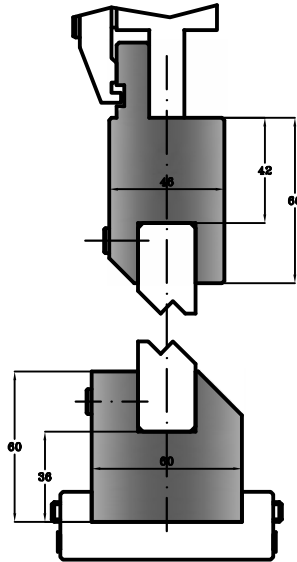

L=835
L=415

WILA/TRUMPF

Cod.12.420 100 T/m

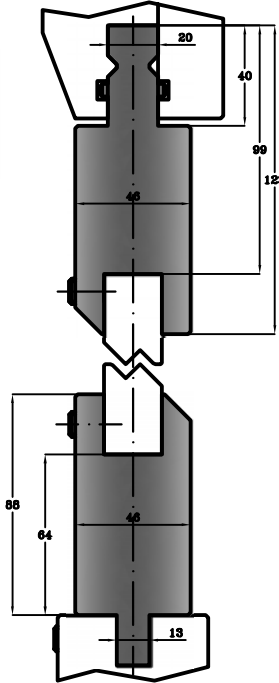

L=835
L=415

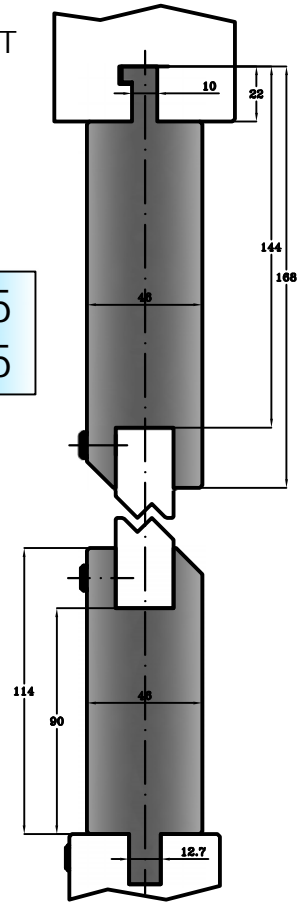

100 T/m

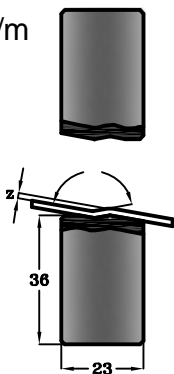

100 T/m

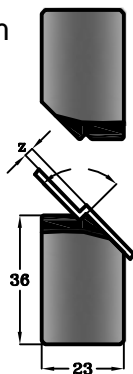

100 T/m

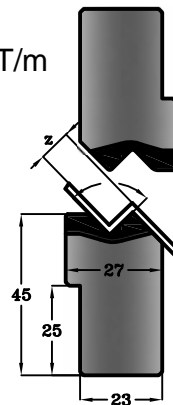

100 T/m

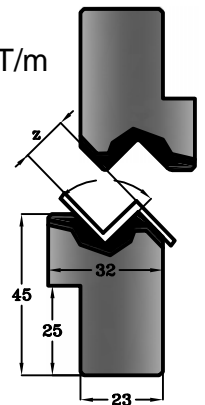

Cod.	Z	
11.300	1.00	160°
11.310	1.50	
11.320	2.00	150°
11.330	2.50	140°

Cod.	Z	
12.760	1.00	90°
12.770	1.50	
12.740	2.00	
12.750	2.50	
11.340	3.00	90°
11.350	3.50	
11.360	4.00	

11.370	4.50	90°
11.380	5.00	
11.390	5.50	
11.400	6.00	
11.410	6.50	
11.420	7.00	
11.430	7.50	
11.440	8.00	

Cod.	Z	
11.450	9.00	90°
11.460	10.0	
11.470	11.0	
11.480	12.0	

Cod.	Z	
12.780	13.0	90°
12.790	14.0	
12.800	15.0	



CONTENITORI ED INSERTI A Z / JOGGLE Z TOOL HOLDER AND INSERT

BEYELER - RFA

Cod.12.998 100 T/m

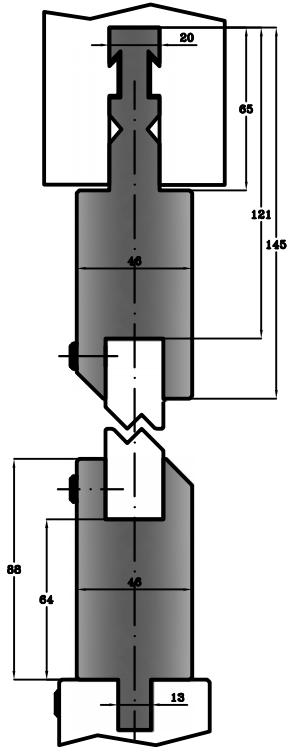

L=835
L=415

BEYELER - R

Cod.11.551 100 T/m

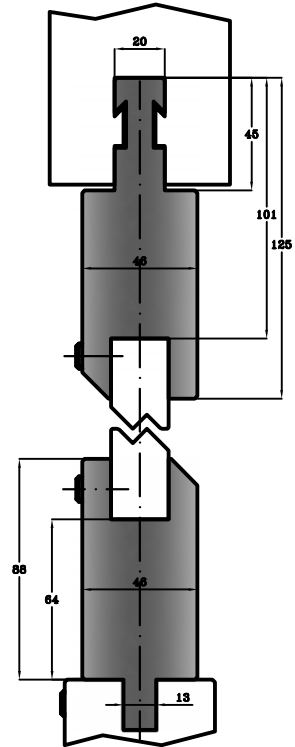

BEYELER - S

Cod.11.552 100 T/m

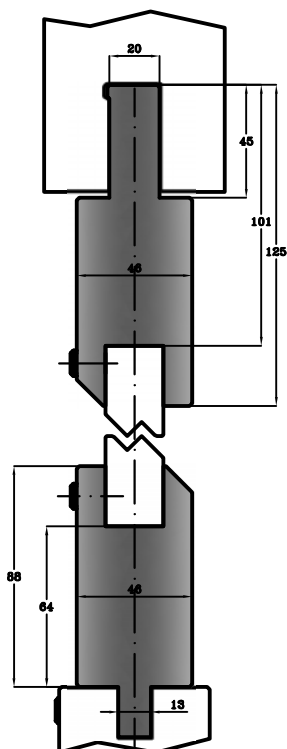

L=835
L=415

EURO - BEYELER

Cod.11.553 100 T/m

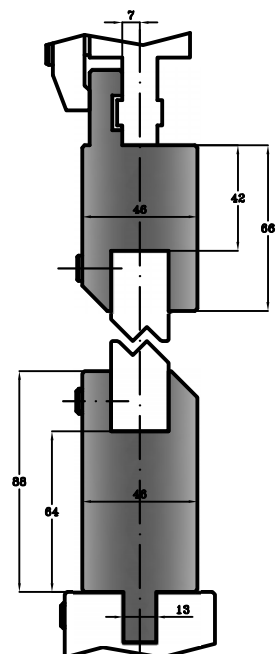



AMADA PROMECAM STYLE

Cod.11.550 80 T/m

SUPPORTO PER
INSERTI TONDI
HOLDER FOR
RADIUS INSERTS

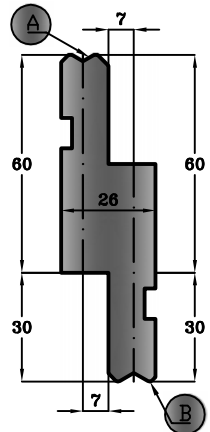

A R=3.0 Min
B R=5.0 Min
 R=4.5 Max R=6.5 Max

L=835
L=415

Cod.10.360 80 T/m

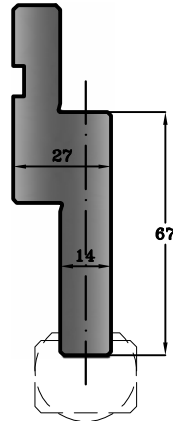

L=835
L=415

Cod.10.960 80 T/m

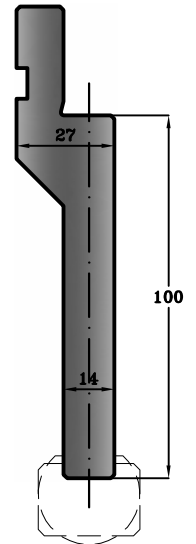

Cod.10.910 80 T/m

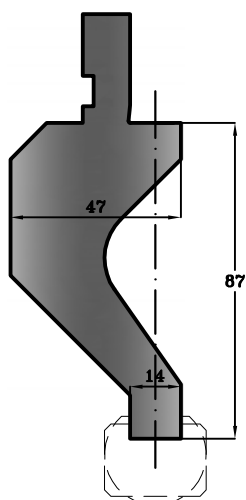

L=835
L=415

Cod.10.900 80 T/m

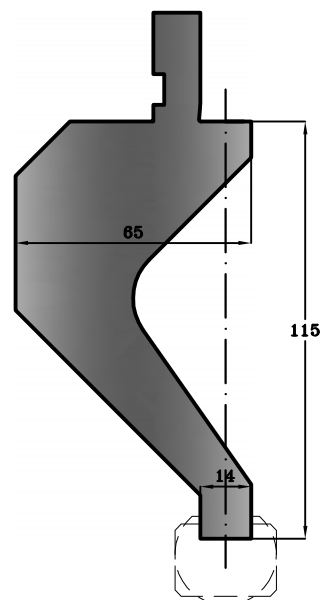



ELEMENTI RAGGIATI / RADIUS TOOL

L=835
L=415

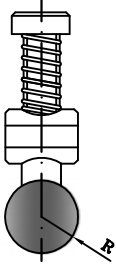

Cod.	R
11.800	3.0
11.810	3.5
11.820	4.0
11.830	4.5
11.840	5.0
11.850	5.5
11.860	6.0
11.870	6.5

Cod. 42.750

Pezzo di ricambio
Spare part

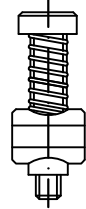

L=835
L=415

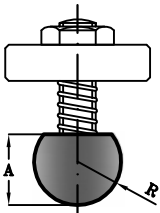

Cod.	R	A
11.000	7.00	11.5
11.010	7.50	11.5
11.020	8.00	13.0
11.030	9.00	16.0
10.370	10.0	16.0
11.040	11.0	16.0
11.050	11.5	16.0
11.060	12.0	20.0

Cod. 10.430

INSERTO PER SCHIACCIARE
FLATTENING INSERT

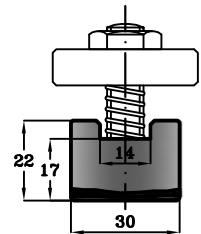

L=835
L=415

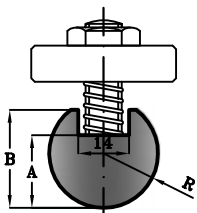

Cod.	R	A	B
11.070	12.5	16.0	21.0
11.080	13.0	17.0	23.0
11.090	14.0	19.0	25.0
10.380	15.0	20.0	27.0
11.100	16.0	21.0	28.0
11.110	17.0	21.5	31.5
10.390	17.5	22.0	32.0
11.120	19.0	25.0	32.0
10.400	20.0	24.0	34.0
11.130	22.5	25.0	33.0
10.410	25.0	29.0	39.0
11.140	27.5	34.0	44.0
10.420	30.0	34.0	44.0
11.150	35.0	45.0	55.0
11.160	40.0	45.0	55.0
11.170	45.0	50.0	60.0
11.180	50.0	54.0	64.0

Cod. 42.740

Pezzo di ricambio
Spare part

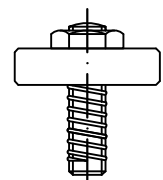



L=835
L=415

SUPPORTI E INSERTI RAGGIATI-PIANI
SUPPORT AND RADIUS-PLAIN INSERT

Cod. 12.390 80 T/m

BEYELER-R

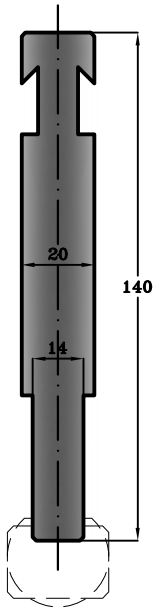

Cod. 12.410 80 T/m

BEYELER-S

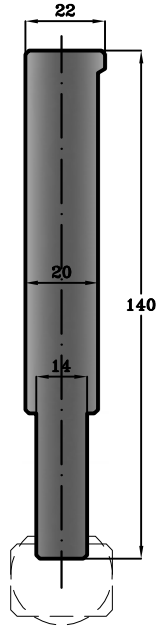

Cod. 12.730 80 T/m

BEYELER-RFA

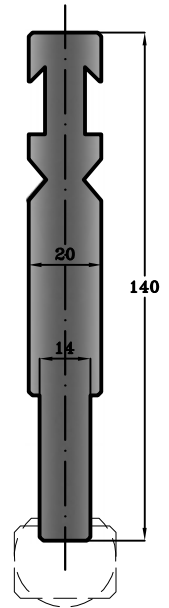

Cod. 12.400 80 T/m

WILA-TRUMPF

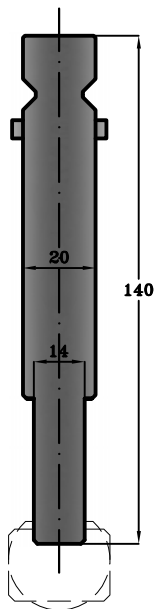

Cod. 14.105 80 T/m

LVD

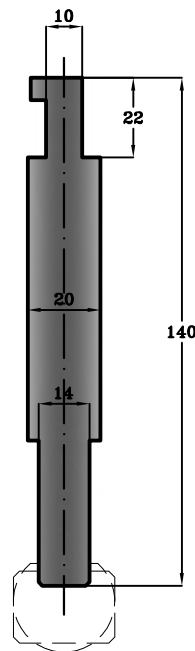



L=835
L=415

CONTENITORI E INSERTI IN POLIURETANO
HOLDERS AND INSERTS IN POLYURETHANE

Cod. 20.360

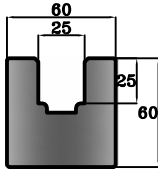

Cod. 21.010

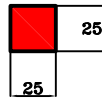

Cod. 21.050

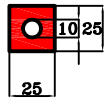

Cod. 20.370

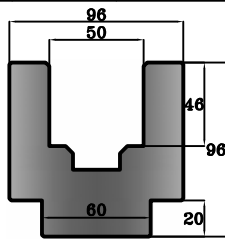

Cod. 21.020

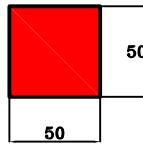

Cod. 21.060

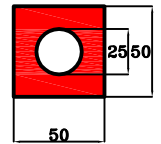

Cod. 20.380

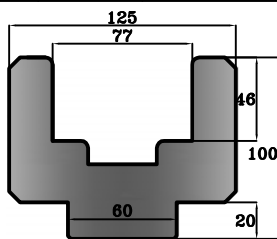

Cod. 21.030

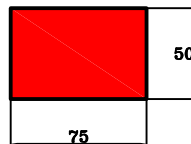

Cod. 21.070

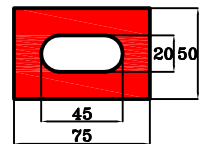

Cod. 20.400

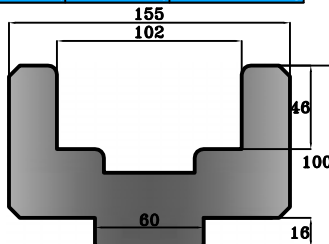

Cod. 21.040

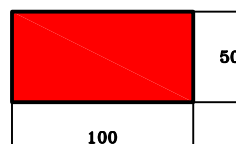

Cod. 21.080

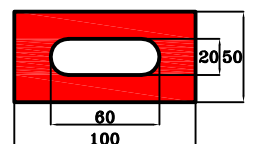



CONTENITORI PER INSERTI IN NYLON INTERCAMBIABILI HOLDER FOR INTERCHANGEABLE PLASTIC INSERTS

Cod. 21.090 100 T/m

L=835
L=415

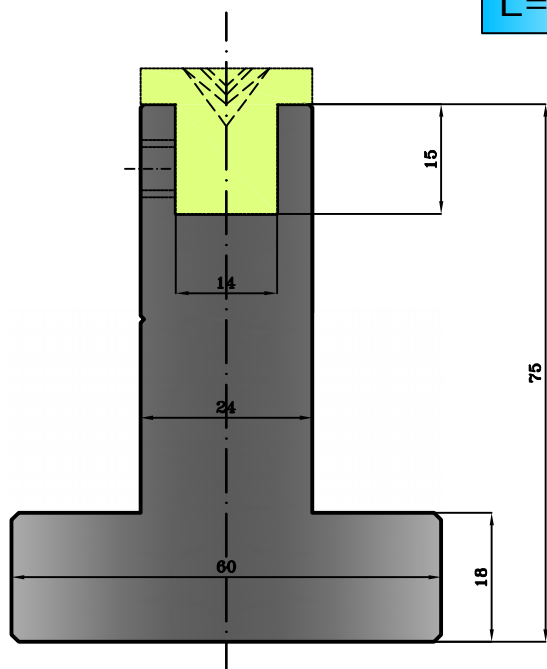

Cod. 21.100 100 T/m

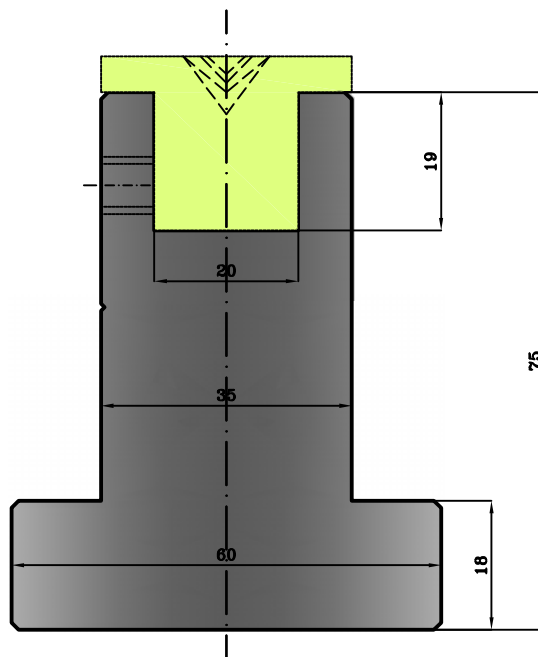

Cod. 21.110 100 T/m

L=835
L=415

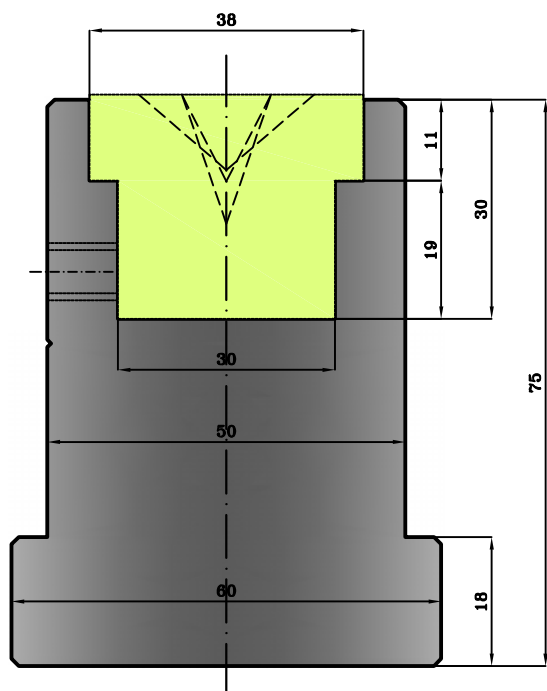

Cod. 21.150 H=50 100 T/m
Cod. 21.160 H=95 100 T/m

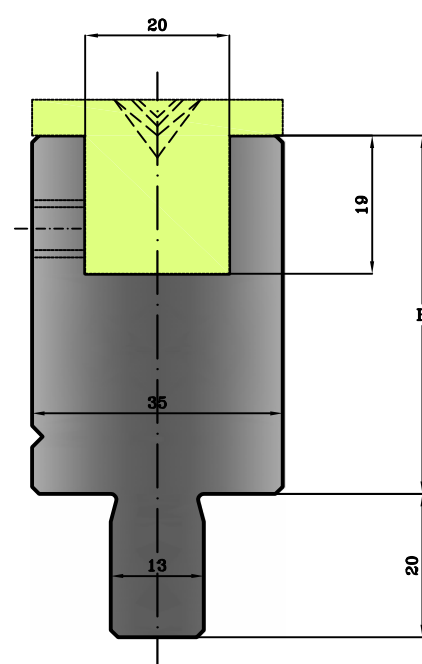



INSERTI IN NYLON INTERCAMBIABILI INTERCHANGEABLE PLASTIC INSERTS

Cod.	Spessore Thickness	Largh. Width	Lungh. Width
43.080	0.8 mm	95mm	33 m
43.140	0.5 mm	95mm	33 m

PELLICOLA DI POLIURETANO ANTIGRAFFIO
FILM OF POLYURETHANE ANTISCRATCH



21.120			
A	V		
88°	6	8	10
60°	6	8	10
45°	6	8	10
30°	6	8	

21.120 20 T/m

L=835
L=415

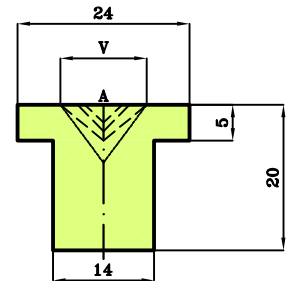

21.130 20 T/m

21.130					
A	V				
88°	6	8	10	12	16
60°	6	8	10	12	16
45°	6	8	10	12	
30°	6	8	10		

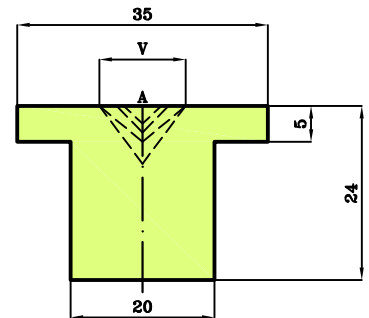

21.140 20 T/m

21.140							
A	V						
88°	6	8	10	12	16	20	25
60°	6	8	10	12	16	20	
45°	6	8	10	12	16	20	
30°	6	8	10	12	16		

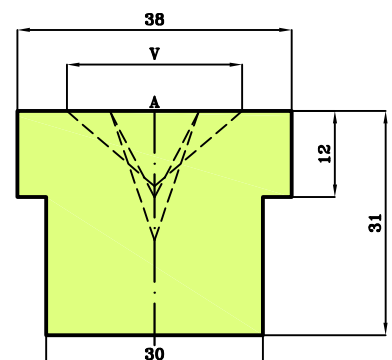



LAME PER CESCOIA / SHEAR BLADES

Lame a 2 fili

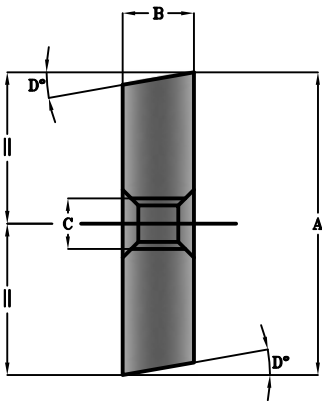

Lame a 2 fili fori svasati

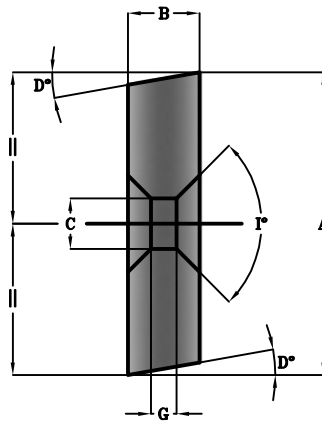

Lame a 2 fili complanari

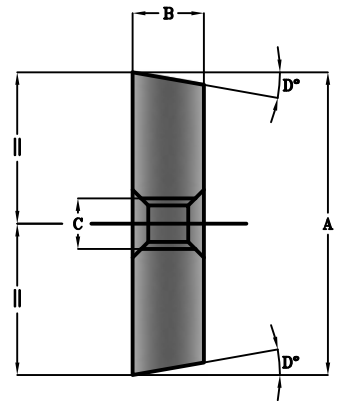

Lame a 4 fili fori svasati

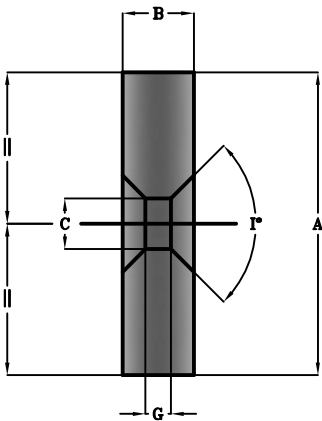

Lame a 4 fili

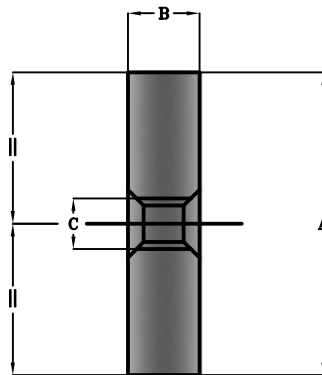

Lame a 4 fili

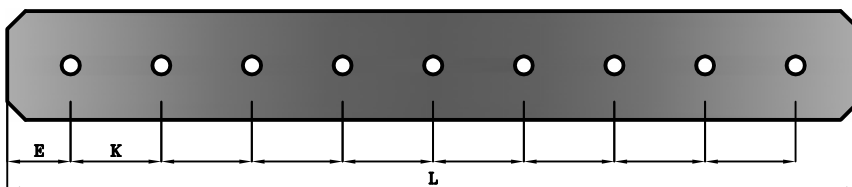
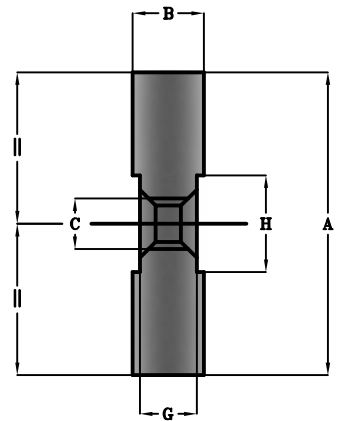

Modello 1
Model 1

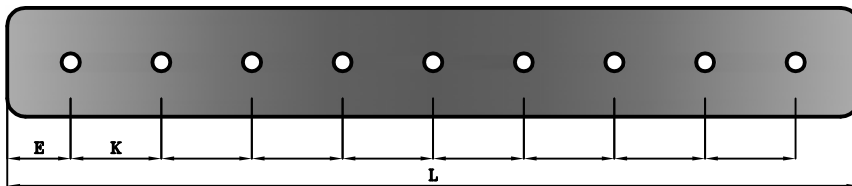

Modello 2
Model 2

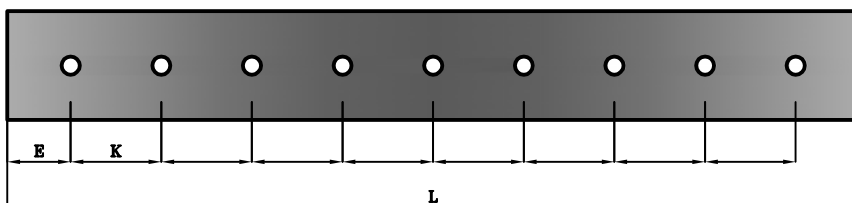

Modello 3
Model 3



LAME PER CESCOIA / SHEAR BLADES

Modulo di richiesta per lame di cesoia
Request form for shear blades

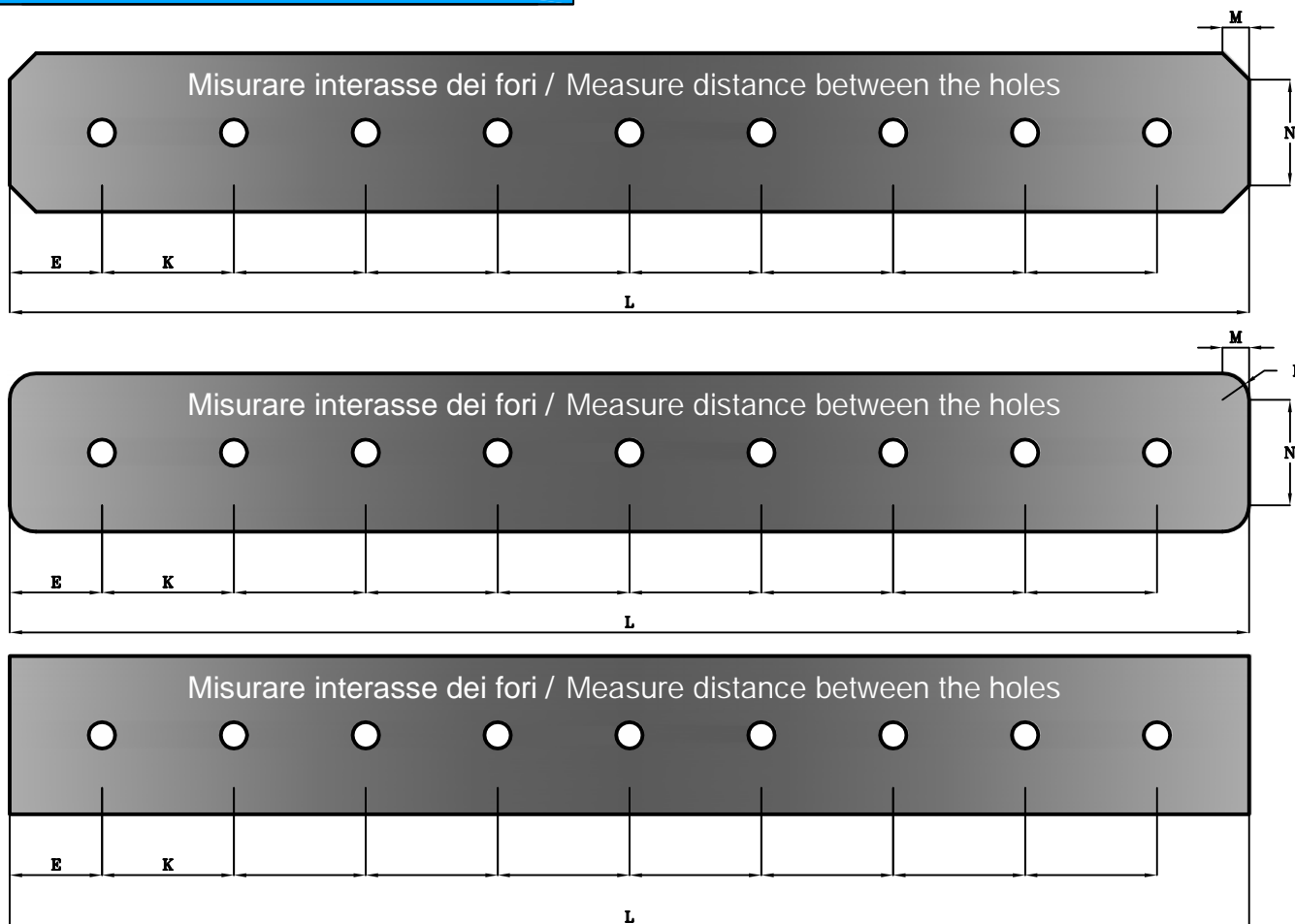

Cesoia: _____ Modello: _____ N° Fori: _____ Lamiera Sp: _____	
Materiale Tagliato / Cut material	Quota / Dimension
Alluminio / Aluminium	A
	B
	C
Ferro / Mild Steel	D
	E
	G
Acciaio Inossidabile / Stainless Steel	H
	I
	K
Altro Materiale / Other material -----	L
	M
	N
	R

ACCESSORIES

DESCRIPTION	CODE	SIZE mm	KG.	PVP	
				€	
Joggle Z tool holder <i>Amada-Promecam</i>	11.500	835	38	€	937,50
		415		€	498,75
Joggle Z tool holder <i>Wila-Trumpf</i>	12.420	835	50	€	1.602,50
		415		€	906,25
Joggle Z tool holder <i>LVD</i>	14.106	835	72	€	1.525,00
		415		€	831,25
Joggle Z tool insert <i>Z=1/160°</i>	11.300	835	10	€	472,50
		415		€	258,75
Joggle Z tool insert <i>Z=1,5/160°</i>	11.310	835	10	€	472,50
		415		€	258,75
Joggle Z tool insert <i>Z=2/150°</i>	11.320	835	10	€	472,50
		415		€	258,75
Joggle Z tool insert <i>Z=2,5/140°</i>	11.330	835	10	€	472,50
		415		€	258,75
Joggle Z tool insert <i>Z=1/90°</i>	12.760	835	10	€	472,50
		415		€	258,75
Joggle Z tool insert <i>Z=1,5/90°</i>	12.770	835	10	€	472,50
		415		€	258,75
Joggle Z tool insert <i>Z=2/90°</i>	12.740	835	10	€	472,50
		415		€	258,75
Joggle Z tool insert <i>Z=2,5/90°</i>	12.750	835	10	€	472,50
		415		€	258,75
Joggle Z tool insert <i>Z=3/90°</i>	11.340	835	10	€	472,50
		415		€	258,75
Joggle Z tool insert <i>Z=3,5/90°</i>	11.350	835	10	€	472,50
		415		€	258,75
Joggle Z tool insert <i>Z=4/90°</i>	11.360	835	10	€	472,50
		415		€	258,75
Joggle Z tool insert <i>Z=4,5/90°</i>	11.370	835	10	€	472,50
		415		€	258,75
Joggle Z tool insert <i>Z=5/90°</i>	11.380	835	10	€	472,50
		415		€	258,75
Joggle Z tool insert <i>Z=5,5/90°</i>	11.390	835	10	€	472,50
		415		€	258,75
Joggle Z tool insert <i>Z=6/90°</i>	11.400	835	10	€	472,50
		415		€	258,75
Joggle Z tool insert <i>Z=6,5/90°</i>	11.410	835	10	€	472,50
		415		€	258,75
Joggle Z tool insert <i>Z=7/90°</i>	11.420	835	10	€	472,50
		415		€	258,75
Joggle Z tool insert <i>Z=7,5/90°</i>	11.430	835	10	€	472,50
		415		€	258,75
Joggle Z tool insert <i>Z=8/90°</i>	11.440	835	10	€	472,50
		415		€	258,75
Joggle Z tool insert <i>Z=9/90°</i>	11.450	835	11	€	528,75
		415		€	291,25
Joggle Z tool insert <i>Z=10/90°</i>	11.460	835	11	€	528,75
		415		€	291,25
Joggle Z tool insert <i>Z=11/90°</i>	11.470	835	11	€	528,75
		415		€	291,25
Joggle Z tool insert <i>Z=12/90°</i>	11.480	835	11	€	528,75
		415		€	291,25

Costo Transporte hasta domicilio del Sr. Cte.: Si el costo del Pedido es inferior a 500€ costo 60€, si el Pedido es entre 501 y 1.000 € el costo es de 30€ si el Pedido es superior a 1.001€ SIN COSTE

ACCESSORIES

Joggle Z tool insert <i>Z=13/90°</i>	12.780	835	11	€	528,75
		415		€	291,25
Joggle Z tool insert <i>Z=14/90°</i>	12.790	835	11	€	528,75
		415		€	291,25
Joggle Z tool insert <i>Z=15/90°</i>	12.800	835	11	€	528,75
		415		€	291,25
Joggle Z tool holder <i>Beyeler RFA</i>	12.998	835	51	€	1.687,50
		415		€	910,00
Joggle Z tool holder <i>Beyeler R</i>	11.551	835	49	€	1.625,00
		415		€	875,00
Joggle Z tool holder <i>Beyeler S</i>	11.552	835	50	€	1.500,00
		415		€	812,50
Joggle Z tool holder <i>Beyeler Euro B</i>	11.553	835	37	€	1.125,00
		415		€	625,00
Radius insert holder	11.550	835	9,6	€	340,00
		415		€	220,00
Punch <i>H=67</i>	10.360	835	9	€	165,00
		415		€	93,75
Radius tool holder <i>H=100</i>	10.960	835	13	€	262,50
		415		€	143,75
Radius tool holder <i>H=87</i>	10.910	835	16	€	511,25
		415		€	287,50
Radius tool holder <i>H=115</i>	10.900	835	26	€	681,25
		415		€	380,00
Radius tool <i>R=3</i>	11.800	835	0,19	€	70,00
		415		€	41,25
Radius tool <i>R=3,5</i>	11.810	835	0,25	€	77,50
		415		€	43,75
Radius tool <i>R=4</i>	11.820	835	0,33	€	83,75
		415		€	47,50
Radius tool <i>R=4,5</i>	11.830	835	0,42	€	92,50
		415		€	51,25
Radius tool <i>R=5</i>	11.840	835	0,51	€	96,25
		415		€	53,75
Radius tool <i>R=5,5</i>	11.850	835	0,62	€	102,50
		415		€	57,50
Radius tool <i>R=6</i>	11.860	835	0,74	€	110,00
		415		€	61,25
Radius tool <i>R=6,5</i>	11.870	835	0,87	€	118,75
		415		€	66,25
Radius tool <i>R=7</i>	11.000	835	0,8	€	80,00
		415		€	43,75
Radius tool <i>R=7,5</i>	11.010	835	1	€	80,00
		415		€	43,75
Radius tool <i>R=8</i>	11.020	835	1,2	€	80,00
		415		€	43,75
Radius tool <i>R=9</i>	11.030	835	1,6	€	87,50
		415		€	47,50
Radius tool <i>R=10</i>	10.370	835	1,6	€	61,25
		415		€	36,25
Radius tool <i>R=11</i>	11.040	835	2,1	€	106,25
		415		€	57,50
Radius tool <i>R=11,5</i>	11.050	835	2,5	€	106,25
		415		€	57,50
Radius tool <i>R=12</i>	11.060	835	2,7	€	106,25
		415		€	57,50

Costo Transporte hasta domicilio del Sr. Cte.: Si el costo del Pedido es inferior a 50€ costo 60€, si el Pedido es entre 501 y 1.000 € el costo es de 30€ si el Pedido es superior a 1.001€ SIN COSTE

ACCESSORIES

Radius tool <i>R=12,5</i>	11.070	835	3,5	€	117,50
		415		€	66,25
Radius tool <i>R=13</i>	11.080	835	3,3	€	117,50
		415		€	66,25
Radius tool <i>R=14</i>	11.090	835	4	€	117,50
		415		€	66,25
Radius tool <i>R=15</i>	10.380	830	9	€	91,25
		410		€	52,50
Radius tool <i>R=16</i>	11.100	835	5,2	€	138,75
		415		€	76,25
Radius tool <i>R=17</i>	11.110	835	5,8	€	138,75
		415		€	76,25
Radius tool <i>R=17,5</i>	10.390	830	9	€	95,00
		410		€	53,75
Radius tool <i>R=19</i>	11.120	835	6,3	€	150,00
		415		€	87,50
Radius tool <i>R=20</i>	10.400	830	9	€	111,25
		410		€	68,75
Radius tool <i>R=22,5</i>	11.130	835	8,2	€	176,25
		415		€	98,75
Radius tool <i>R=25</i>	10.410	830	9	€	122,50
		410		€	71,25
Radius tool <i>R=27,5</i>	11.140	835	12,5	€	198,75
		415		€	110,00
Radius tool <i>R=30</i>	10.420	830	9	€	146,25
		410		€	91,25
Radius tool <i>R=35</i>	11.150	835	21	€	302,50
		415		€	161,25
Radius tool <i>R=40</i>	11.160	835	24	€	350,00
		415		€	187,50
Radius tool <i>R=45</i>	11.170	835	29,5	€	406,25
		415		€	220,00
Radius tool <i>R=50</i>	11.180	835	34,5	€	432,50
		415		€	231,25
Flattening insert <i>H=17</i>	10.430	835	3,5	€	98,75
		415		€	55,00
Support and radius plain insert <i>H=140</i> Beyeler R	12.390	830	15	€	301,25
		412		€	178,75
				€	-
Support and radius plain insert <i>H=140</i> Beyeler S	12.410	830	16	€	280,00
		412		€	167,50
				€	-
Support and radius plain insert <i>H=140</i> Beyeler RFA	12.730	830	16	€	315,00
		412		€	191,25
				€	-
Support and radius plain insert <i>H=140</i> Wila-Trumpf	12.400	830	16	€	355,00
		412		€	207,50
				€	-
Support and radius plain insert <i>H=140</i> LVD	14.105	830	18	€	462,50
		412		€	262,50
				€	-
Polyurethane holder for ins. size 25x25	20.360	835	18,5	€	293,75
		415		€	171,25
Polyurethane insert 25x25	21.010	835	0,65	€	131,25
		415		€	67,50
				€	-

Costo Transporte hasta domicilio del Sr. Cte.: Si el costo del Pedido es inferior a 500€ costo 60€, si el Pedido es entre 501 y 1.000 € el costo es de 30€ si el Pedido es superior a 1.001€ SIN COSTE

ACCESSORIES

Polyurethane insert 25x25	21.050	835	0,6	€	150,00
		415		€	81,25
Polyurethane holder for ins. size 50x50	20.370	835	36,5	€	530,00
		415		€	296,25
Polyurethane insert 50x50	21.020	835	2,5	€	306,25
		415		€	162,50
Polyurethane insert 50x50	21.060	835	2,2	€	317,50
		415		€	181,25
Polyurethane holder for ins. size 75x50	20.380	835	45	€	750,00
		415		€	403,75
Polyurethane insert 75x50	21.030	835	3,5	€	397,50
		415		€	206,25
Polyurethane insert 75x50	21.070	835	3,2	€	451,25
		415		€	248,75
Polyurethane holder for ins. Size 100x50	20.400	835	55	€	866,25
		415		€	471,25
Polyurethane insert 100x50	21.040	835	5	€	427,50
		415		€	226,25
Polyurethane insert 100x50	21.080	835	4,5	€	488,75
		415		€	285,00
T insert holder for nylon 20x24	21.090	835	15	€	376,25
		415		€	210,00
T insert holder for nylon 24x35	21.100	835	19	€	376,25
		415		€	210,00
T insert holder for nylon 31x38	21.110	835	22,5	€	376,25
		415		€	210,00
Beyeler insert holder H50 FOR NYLON 24x35	21.150	835	11,5	€	357,50
		415		€	200,00
Beyeler insert holder H50 FOR NYLON 24x35	21.160	835	19,3	€	466,25
		415		€	251,25
Nylon insert size 20x24	21.120	835	0,3	€	160,00
		415		€	91,25
Nylon insert size 24x35	21.130	835	0,4	€	167,50
		415		€	93,75
Nylon insert size 31x38	21.140	835	0,5	€	175,00
		415		€	98,75
Antiscratch polyurethane film thickness 0,8-width 95	43.080	33m	2	€	280,00
				€	-
Antiscratch polyurethane film thickness 0,5-width 95	43140	30m	2	€	280,00
				€	-

Costo Transporte hasta domicilio del Sr. Cte.: Si el costo del Pedido es inferior a 50€ costo 60€, si el Pedido es entre 501 y 1.000 € el costo es de 30€ si el Pedido es superior a 1.001€ SIN COSTE